



How to build your robot

www.pib.rocks/build

assembly instructions for:

HEAD

v2024



PRINT

BUILD

DEVELOP

YOUR OWN ROBOT

Printable and pre-assembled parts



Pib's head consists of **2 printable parts** and is assembled in **15 steps**.

In order to construct the head, you will need to print the parts as seen in the table.

Please note: For better readability we use the abbreviations in the tutorial: A01 instead of A01-Face.

Printable parts

A01-Face

A03-Face_Plate

Non-printable parts



You will also need the following non-printable parts from our pib.Box Master.

If you do not have it yet, you can buy in our shop

<https://shop.pib.rocks>

Non-printable parts

1 x **E01** Raspberry Pi_5

1 x **E02** TinkerForge HAT (with 2-pole-connector)

1 x **E04** OAK D-Lite

1 x **E05** LCD screen
with screws, distancer, speaker, connectors

1 x **E12** USB Microphone

4 x **S01** M3 nuts

2 x **S15** M2.5 12mm screws

4 x **S14** M2.5x6mm

1 x USB to USB-C cable

90 cm black/red cable

1 x Micro-SD-card

Printable parts - Overview

A01-Face

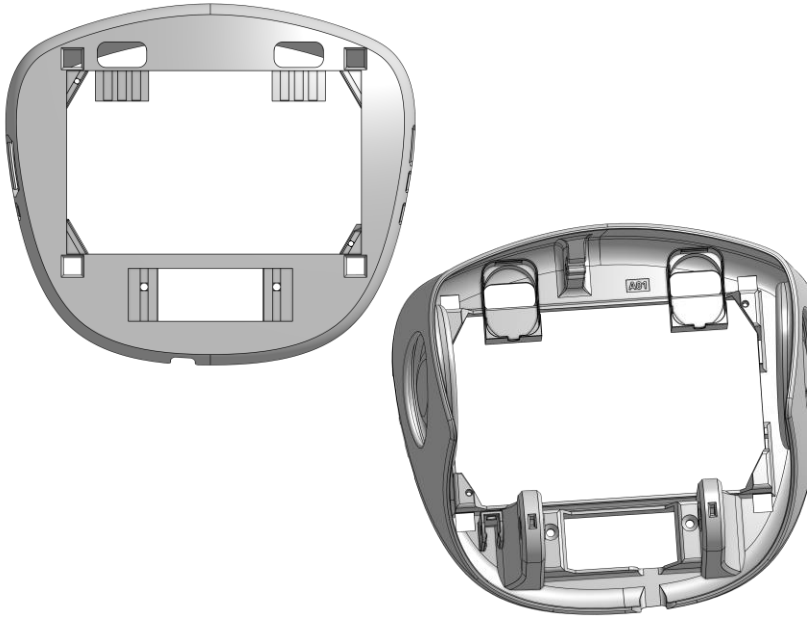

A03-Face_Plate

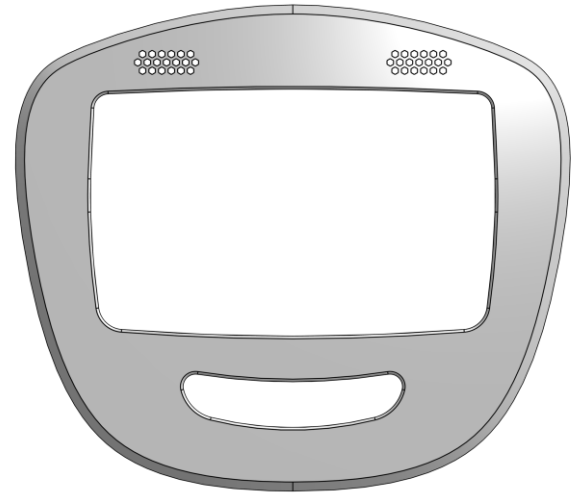

Build it better: our suggestion for assembling pib



We recommend **tools** for each step. These are a suggestion, you can of course also use other tools.



1-5

We have categorized each step according to its **difficulty** - from **1-5** (1 being the easiest, 5 the hardest)



We also show you which **non-printable parts** you need for each step

Step 1



Insert **2 x speakers** (part of the screen package) into the shown spots in the **E05 LCD screen**.

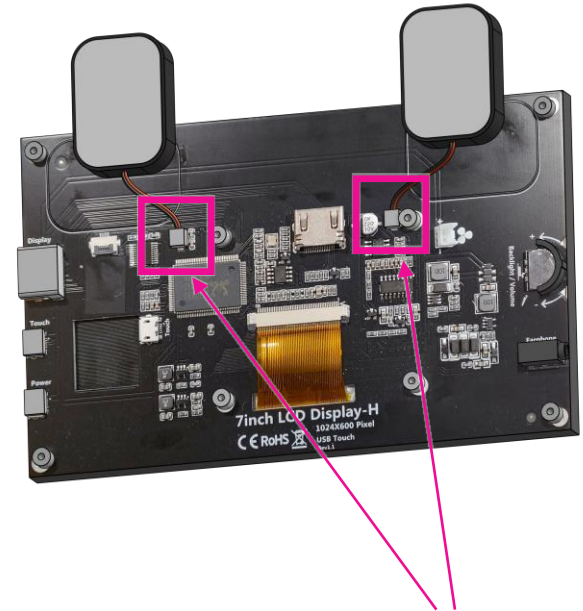
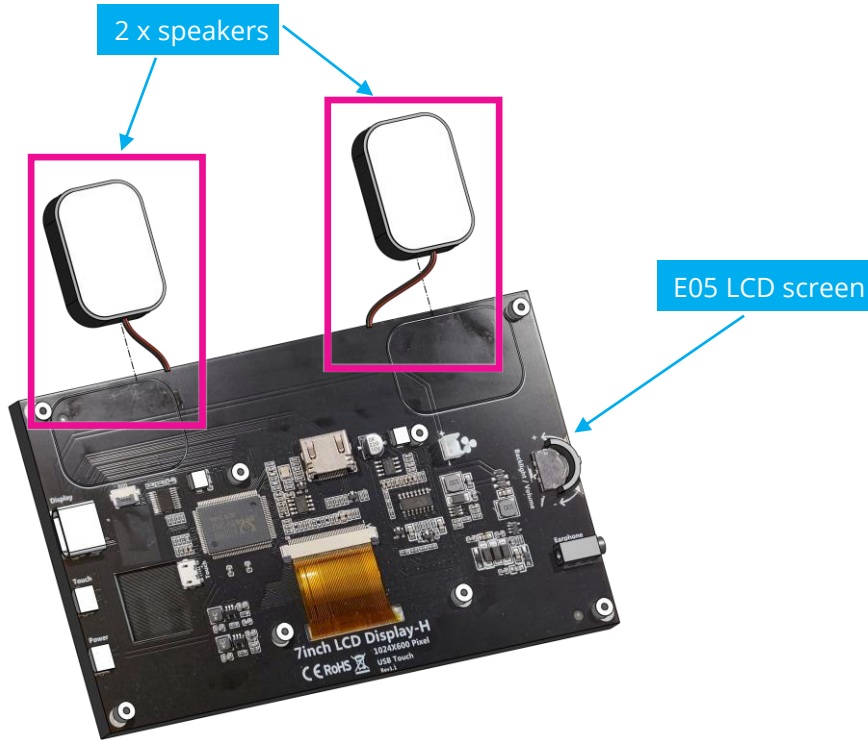

You can see some metal parts on one side of *these* wire connectors. This side has to face down towards the LCD screen.

Step 2

 1  4x

Insert **4 x M2.5 distancers** (part of the screen package) in the shown spots in LCD screen.

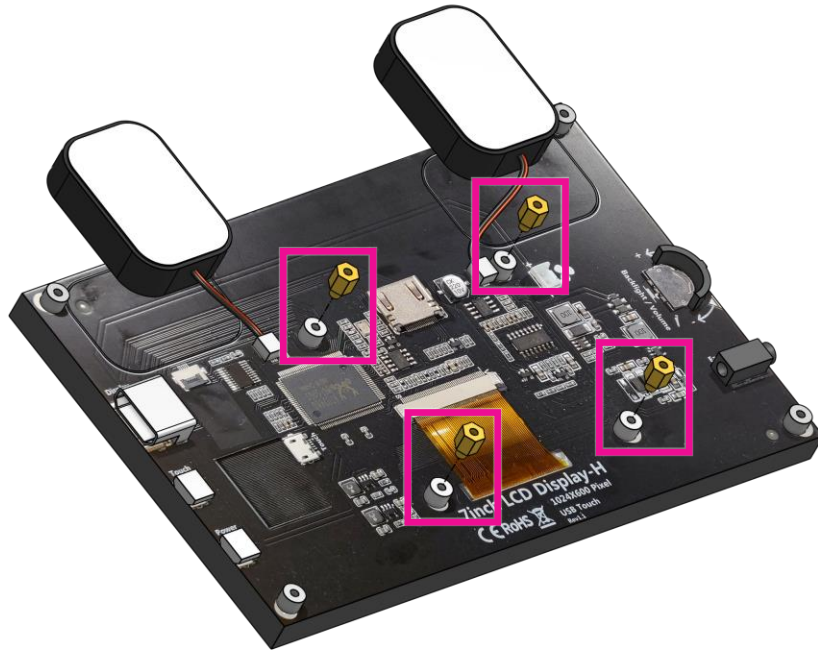

4 x distancers

Remove the protection foil from the *shown spots*.
Don't use tools to put the distancers in.

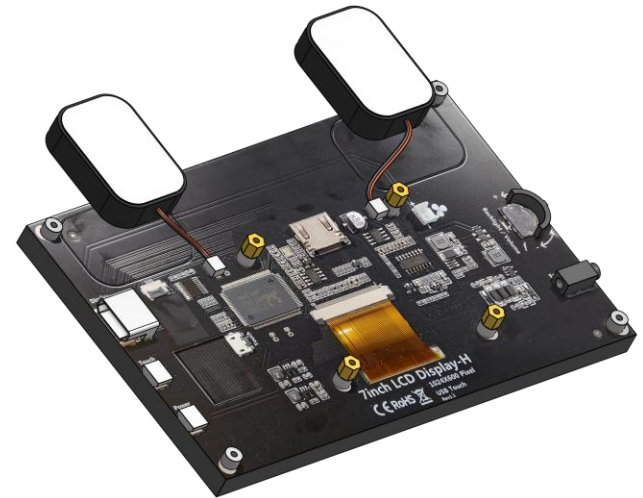

Step 3

Insert the **Micro-SD-card** into the **Raspberry Pi**.

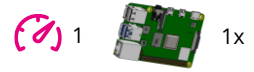

Before you insert the SD card make sure you have installed the pib.software on it.

You can find the tutorial here:
<https://pib.rocks/build/how-to-install-raspberry-pi/>

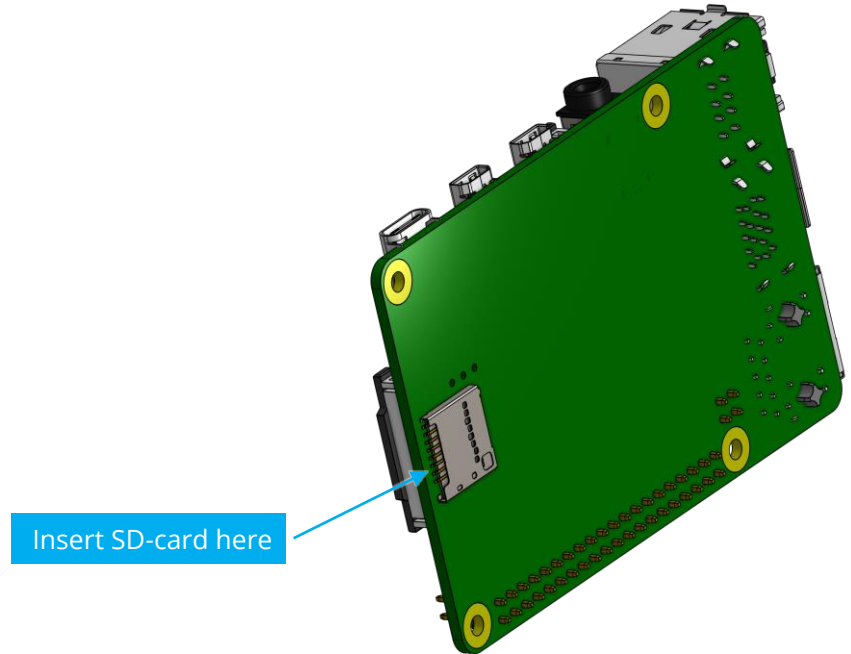

Step 4a

Place the **Raspberry Pi** on top of the **LCD screen** and fix it with with **4 x M2.5 6mm screws** (part of the screen package).

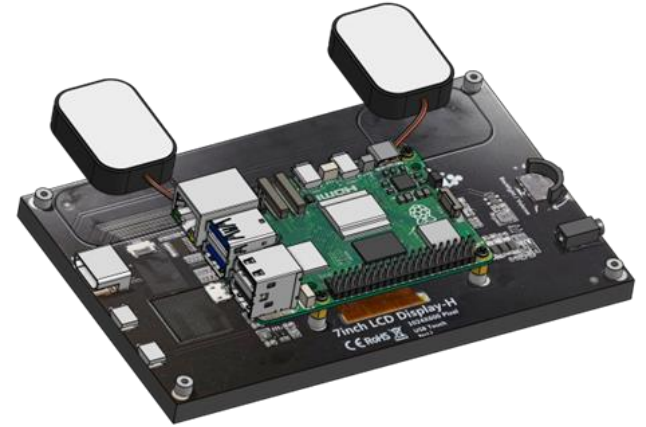
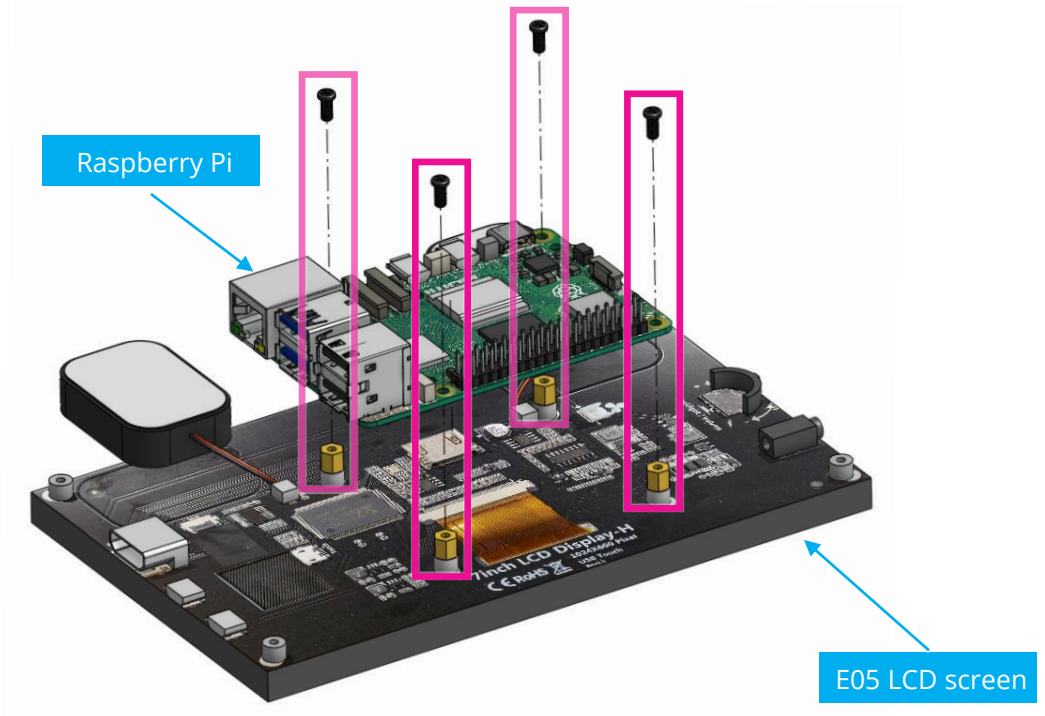

Step 4b

Attach **E18 active cooler** to **Raspberry Pi**.

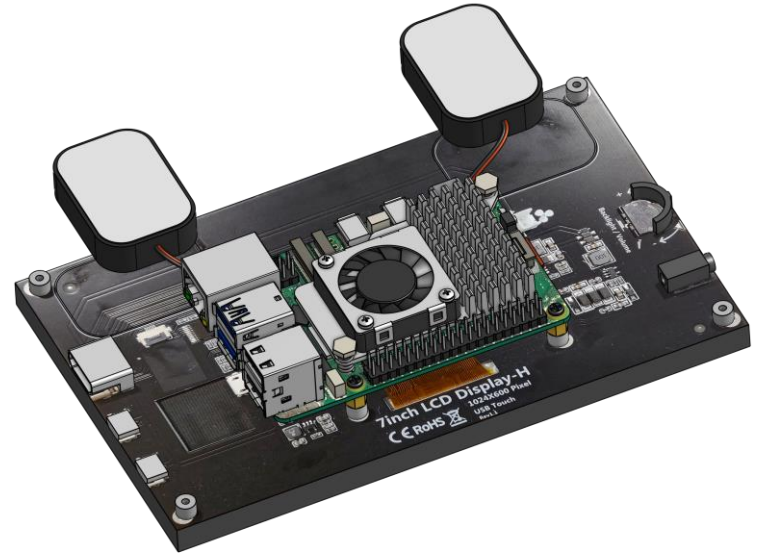
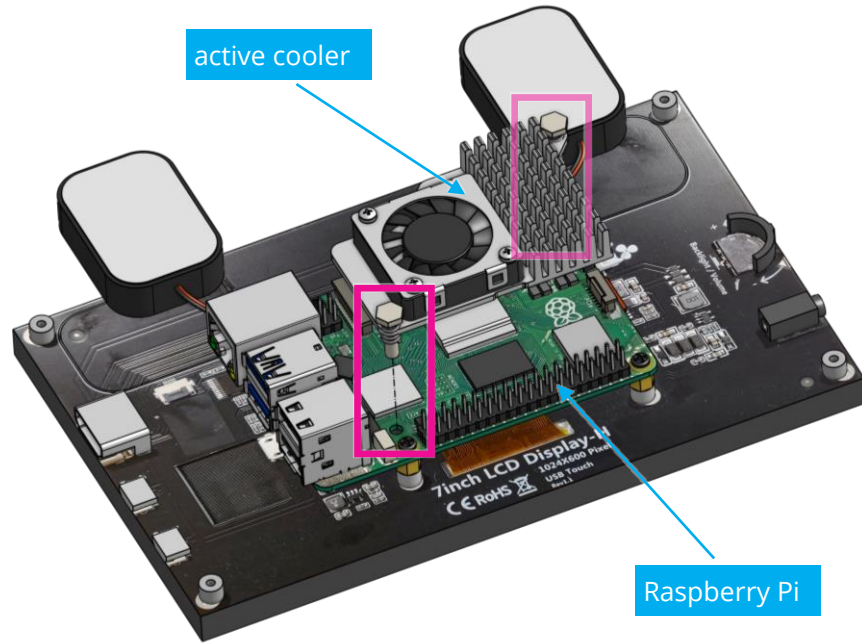
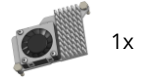

Note

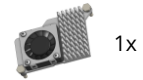

Make sure that **E18 active cooler's** fan wire is connected to "fan" slot in **Raspberry Pi**.

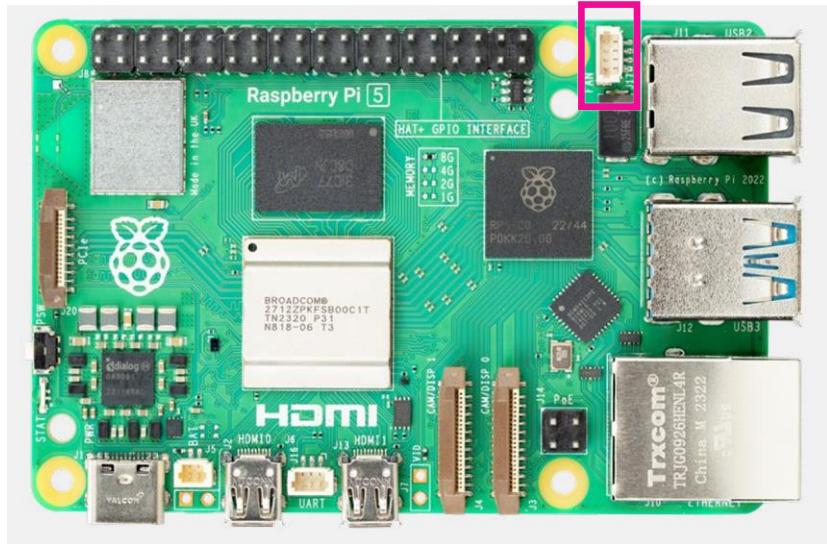

Step 5

Now, we have to connect the **Raspberry Pi** and the **LCD screen** electronically.

For this, there are two connectors (part of the screen package):

- **USB-H 3B** USB connector (responsible for touch screen functionality)
- **H-4B** HDMI connector (responsible for video signal)

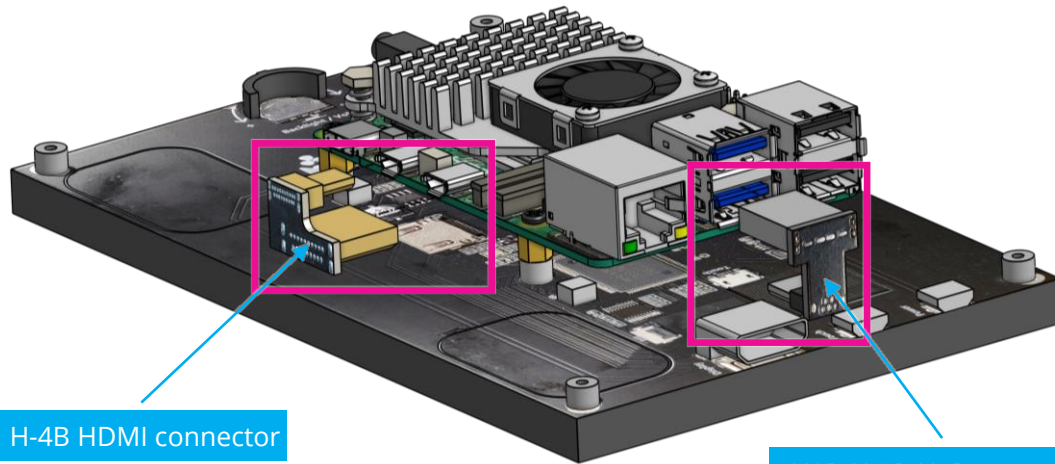
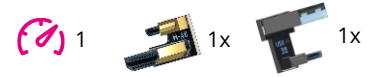

H-4B HDMI connector

USB-H 3B USB connector

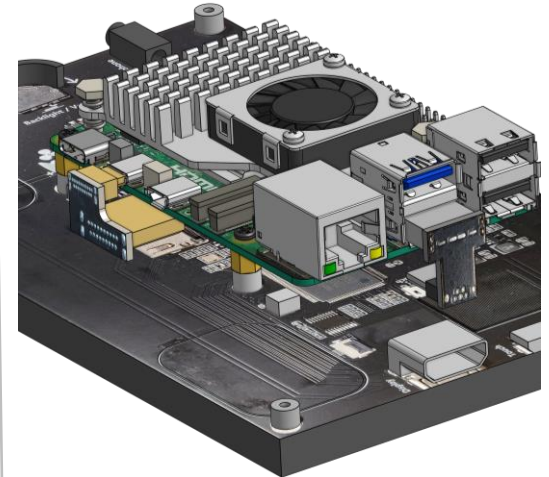

Step 6

Connect **“USB to USB type-c”-cable** in the shown spot for usage of the camera.

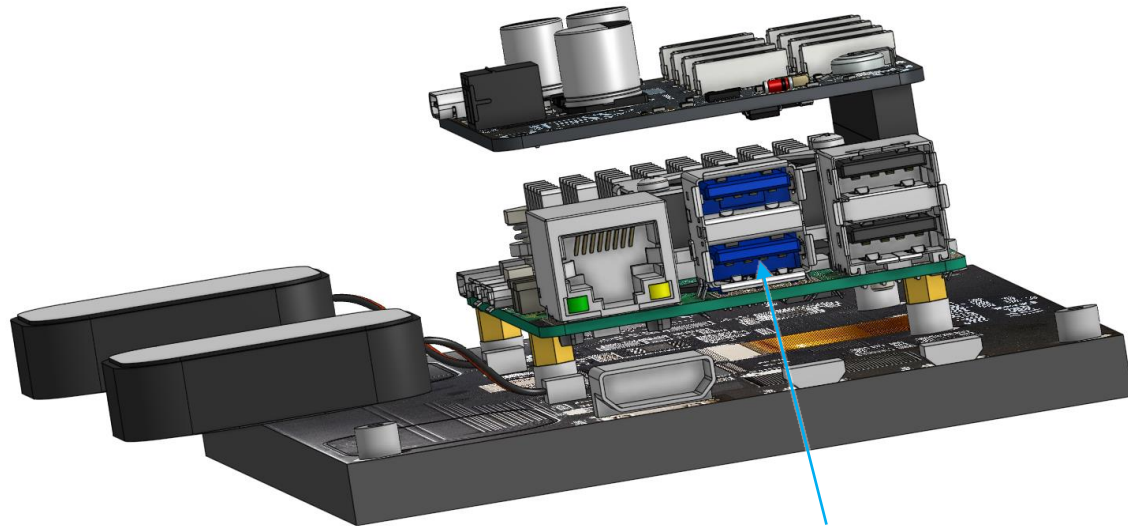

USB to USB type C cable

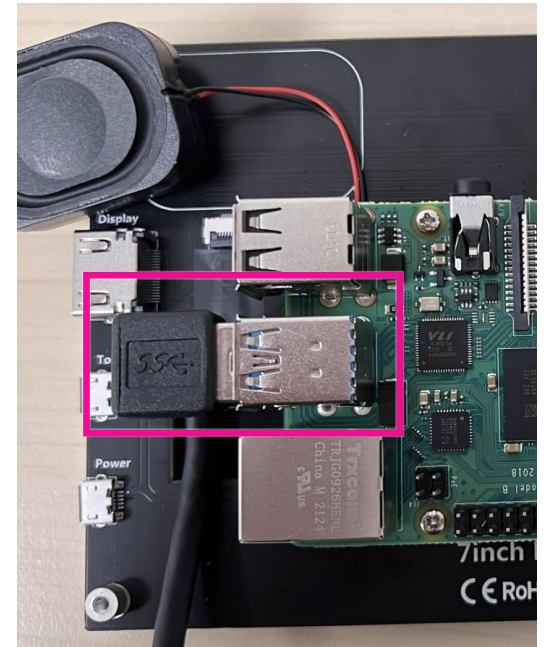

Step 7

Connect the **USB microphone E12** to the shown port of the Raspberry Pi.

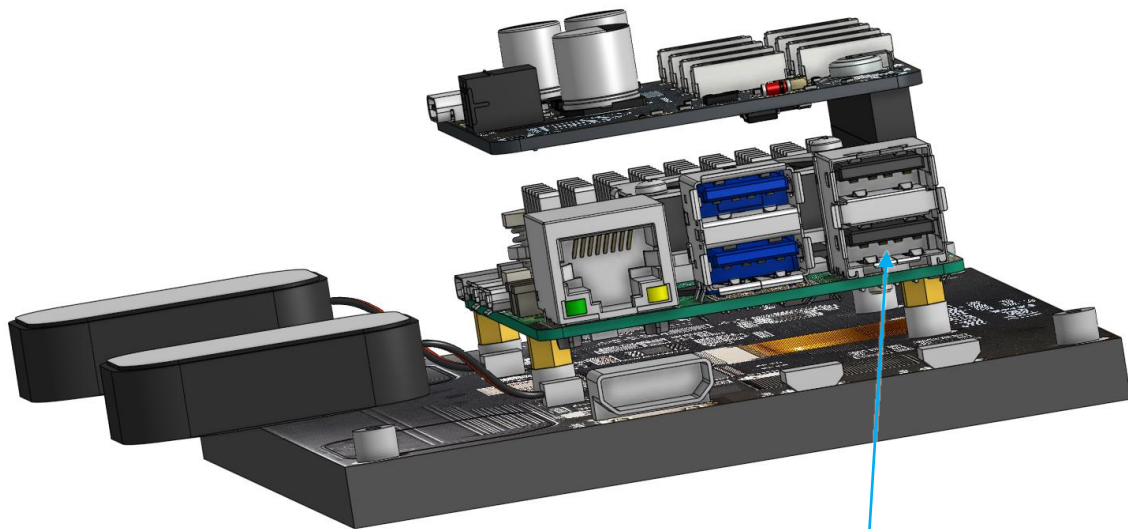

USB microphone

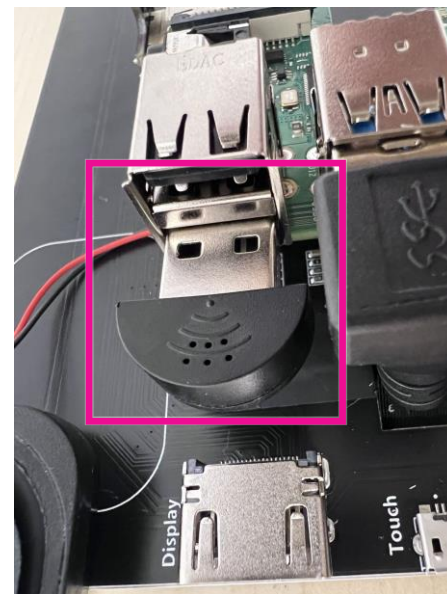

Step 8

Attach the **E02 TinkerForge HAT** to **Raspberry Pi** using the **E17 GPIO extender**.

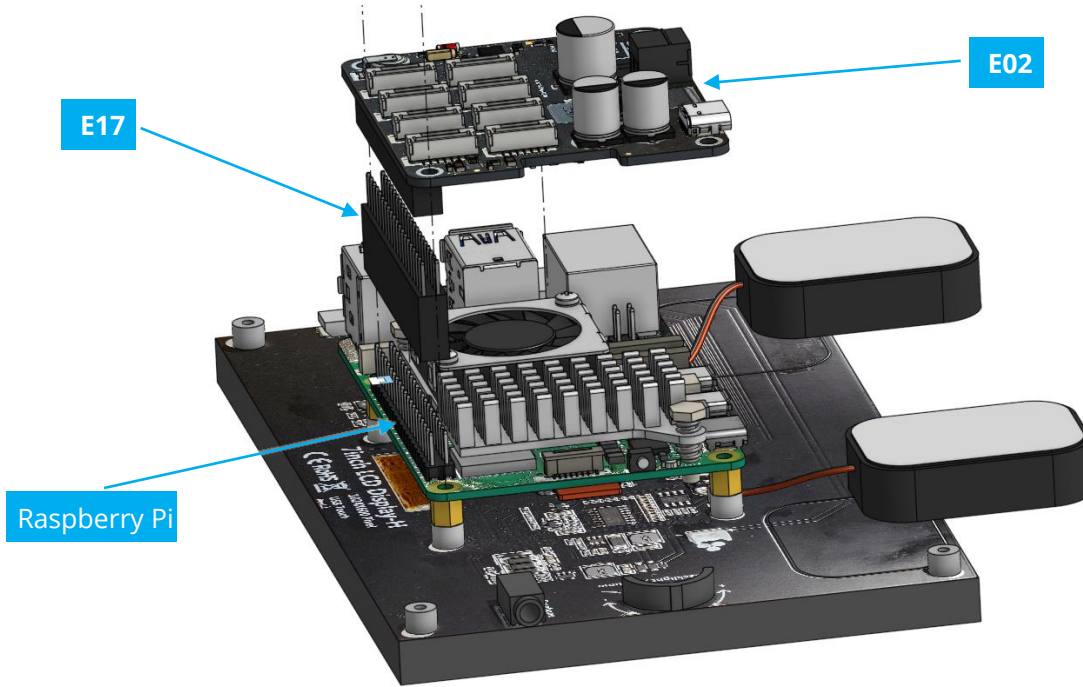

Make sure, the TinkerForge HAT is placed in the shown orientation.

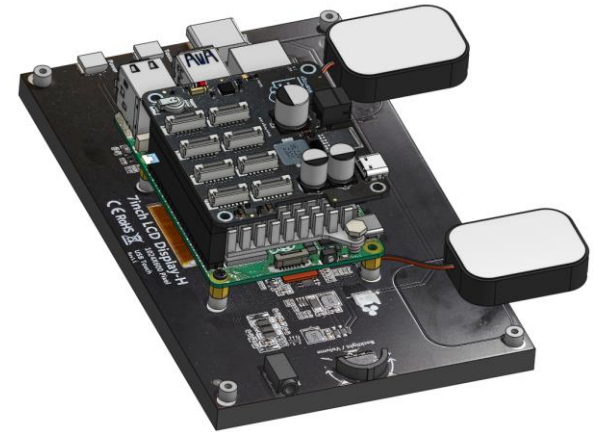

Step 9



Insert the assembly from previous steps to **A01** and fix it using **2 x M2.5 12mm screws** (part of the screen package). Place the speakers in the shown spots of **A01**.

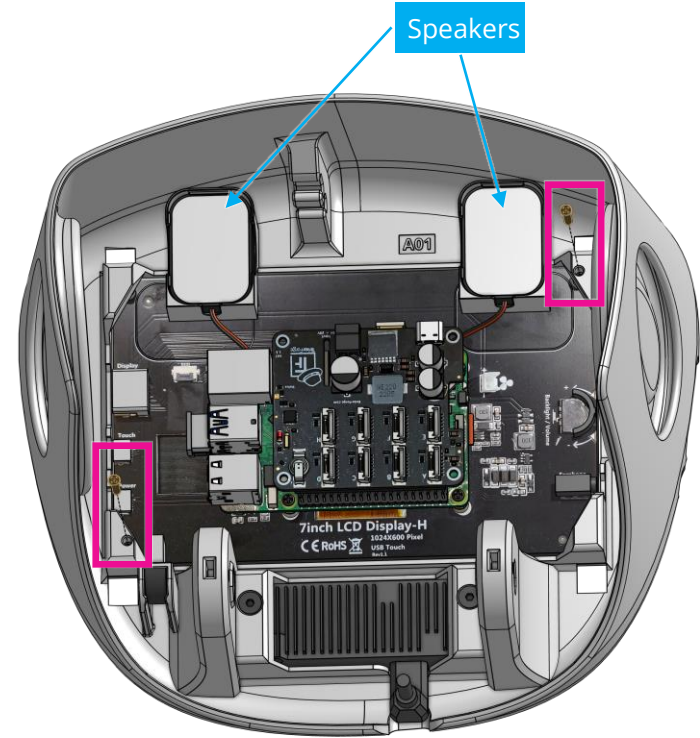
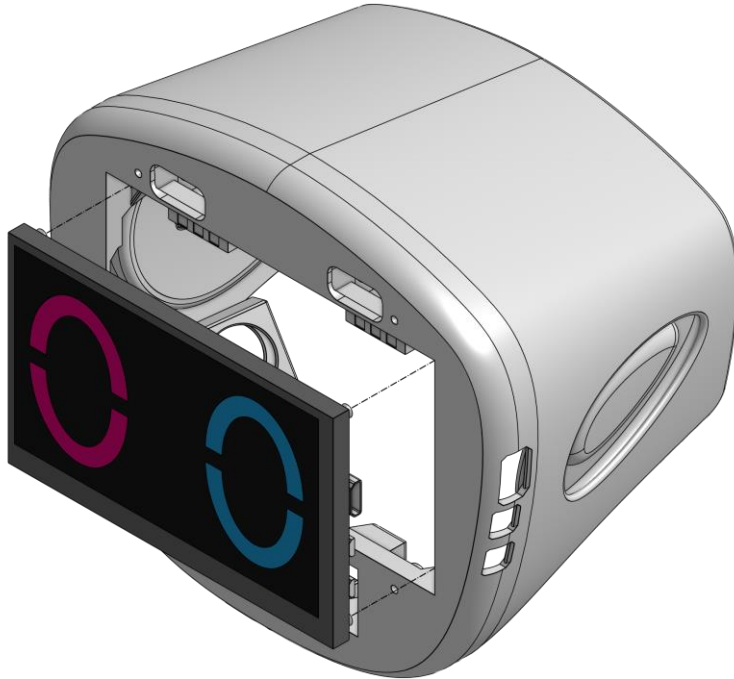

Step 10

Insert the **Oak-D-lite camera** into **A01** and tighten it using **2 x M4 10mm screws**.

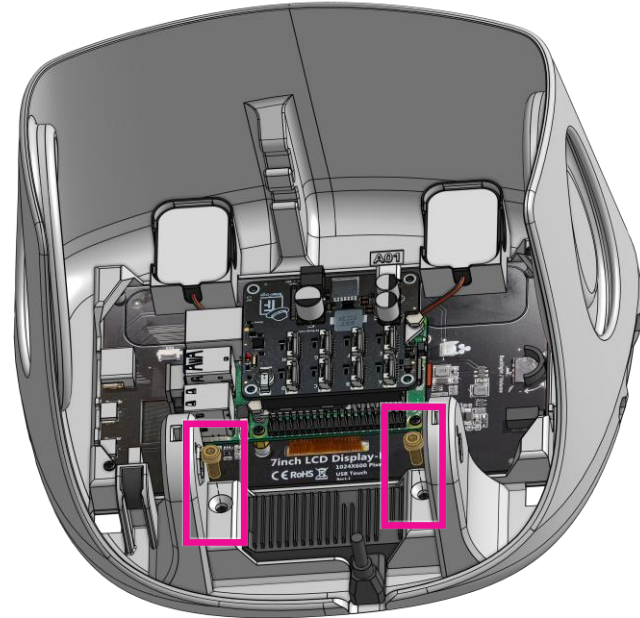

Step 11



Connect the **“USB to USB-type-C”-cable** from **step 6** into the shown spot of the camera.



USB to USB-type-C cable

Step 12

Finally, connect **A03** to **A01**

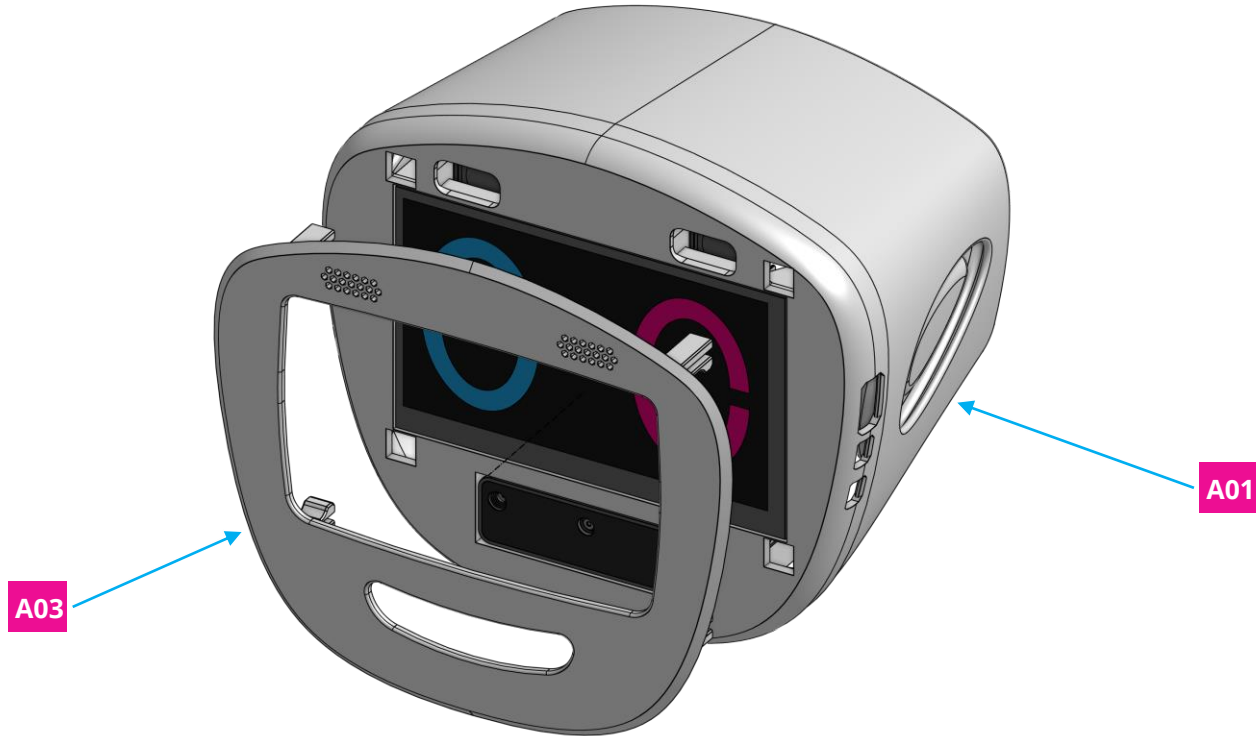

Congratulations

You did a great job, pib´s head is assembled!

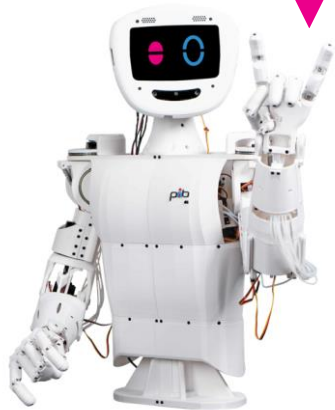

Well done!



Do you need support?



Or do you need our pib.Box with all non-printable parts?

Or maybe you have some new ideas and improvements?

Please contact us.



team@pib.rocks
Send us an email.



discord.com/invite/GRdpyeDu7P
Join us on Discord.



shop.pib.rocks
Order non-printable parts for pib.